

ParticleMaster

Intelligent Imaging for
Particle and Droplet Characterization



LAVISION

FOCUS ON IMAGING



High-magnification shadow imaging

High-magnification shadow imaging

LaVision's **ParticleMaster** imaging systems simultaneously measure size, shape and velocity of individual particles, droplets or bubbles dispersed in gas, liquid or multiphase flows. High-magnification shadow imaging with pulsed backlight illumination of the particles is applied giving confidence in the measurement method, as the user can directly see the results of this particle imaging process.

The measurement volume is defined by the camera field of view in the focal plane and the depth of field of the imaging system detecting only focused particles inside this probe volume. The shadow technique is independent of the shape and material (either transparent or opaque) of the particles and allows the detection of sizes down to the micro scale using appropriate optical imaging systems.

ParticleMaster system features

- ▶ Sizing of droplets, particles and bubbles
- ▶ Any particle shape
- ▶ Particle diameters from $\sim 4 \mu\text{m}$ to several mm
- ▶ Max. particle velocities from 10 m/s to over 100 m/s
- ▶ High magnification imaging and characterization of all detected particles

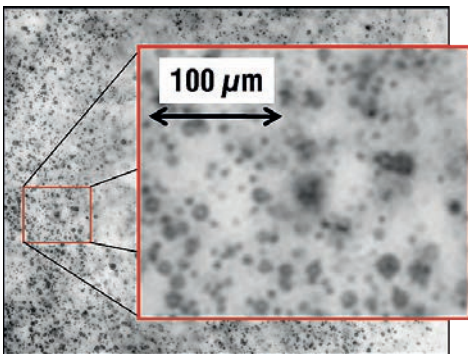

High resolution shadow image

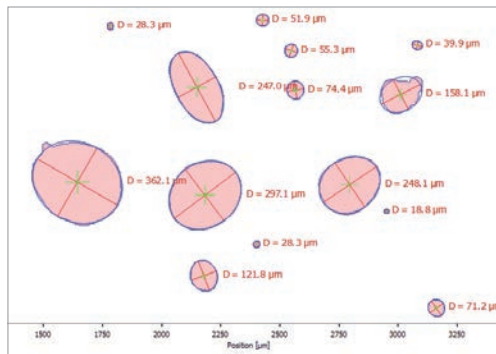

Detected particles

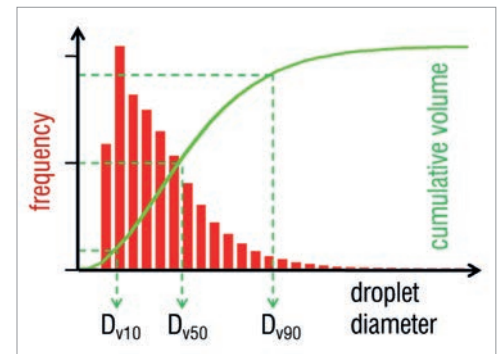

Particle size histogram

In-situ measurement

Sample preparation is not needed, because the **ParticleMaster** imaging systems measure the particles in-situ, i. e. in their original environment.

While the spatial resolution is defined by the camera-lens system the exposure (illumination) time is given by the pulsed light source. With a choice of different light sources - from fast lasers to eye-safe pulsed LEDs - and a variety of interchangeable lenses a wide range of particle sizes and velocities are captured using the **ParticleMaster Shadow** systems.

Comprehensive particle characterization

In addition to statistical information such as cumulated statistics and size distribution, **ParticleMaster** also provides full characterization of individual particles, incl. size shape and velocity.

Powerful software with real time dynamic image analysis

The **ParticleMaster** software package automatically identifies valid particles in an image and calculates all particle properties with outstanding processing speed including statistical information in real-time. This makes it ideal for online monitoring

High accuracy particle characterization

LaVision's advanced Depth-of-field calibration method not only ensures highly accurate particle sizing measurements. It also ensures that the **ParticleMaster** system can deliver absolute number density, volume fraction and absolute mass flux of the particle flow.





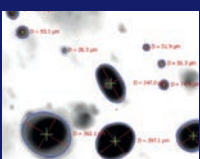

Size





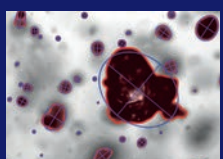

Shape



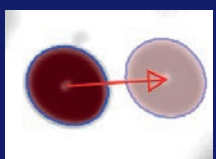

Velocity





Mass Flux

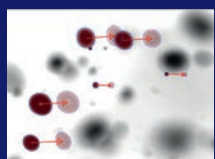

Distribution

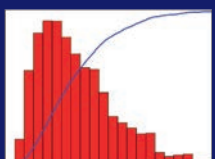

Cumulated Statistics

Statistic	Value
D10	97.5 µm
D32	274.6 µm
Dv10	144.2 µm
Dv50	392.6 µm
Dv90	887.6 µm

ParticleMaster system

LaVision's **ParticleMaster** is a highly advanced **Dynamic Image Analysis (DIA)** system for particle characterization. The key components are a dedicated high magnification imaging system combined with a shortly activated, motion stopping backlight illumination source.

The camera and high magnification lens are selected according to various experimental conditions, like working distance, magnification, size range and desired image frame rate. To freeze the particle motion the ParticleMaster systems include a high efficient LED spotlight or a speckle-free laser pulse for ultra short exposures.

Whether you are sizing droplets, particles or bubbles – there is a ParticleMaster solution for all applications:

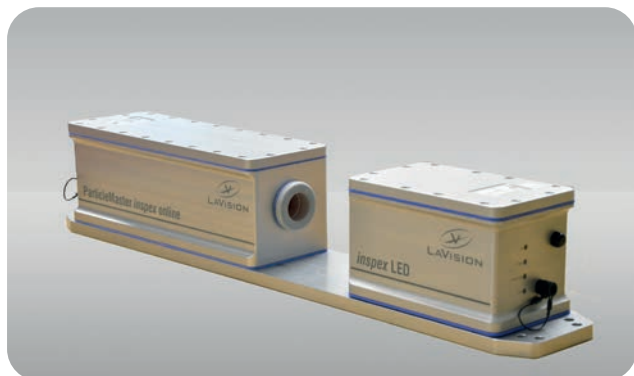

ParticleMaster *inspex* online features rugged hardware designed specifically for 24/7 operation in industrial plants. Combined with real time processing and machine communication capabilities it makes it a powerful production monitoring and quality control system. Software and hardware are specifically designed to be efficiently integrated into production lines.

ParticleMaster *inspex* is a table top sizing system typically used in industrial laboratories. Whether it is used for product development or manual quality control, this system can cover a wide range of applications from small medical devices to large scale sprays. The pre-calibrated systems allow out of the box operation with traceable results.



For all other industrial and scientific R&D applications there is **ParticleMaster Shadow**. These customizable systems can be configured exactly to the application to provide the best and most precise measurement solution. The systems can be based on the full range of LaVision's hardware portfolio incl. high-speed imaging in the kHz range for highly transient applications and laser based illumination for ns-pulse to freeze the motion of even the fastest particles. With Tomo-sizing software particles can even be characterized and tracked in large volumes.



Paint and coating applications

Coating application is a central part to many production processes such as spraying vehicle body paint, functional battery pack coatings or mold release agents. The quality of a coating depends on many factors such a coating formulation, nozzle design and operating parameters. Online monitoring of spray application plays an important role in increasing efficiency and reducing wastage. By detecting overspray, monitoring re-circulate composition, nozzle deterioration and fouling, processes can be adjusted and maintenance downtime can be reduced to a minimum.

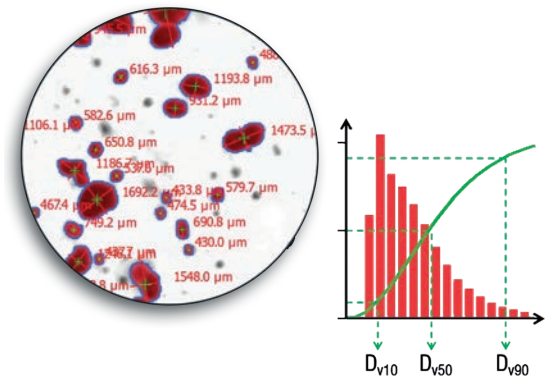
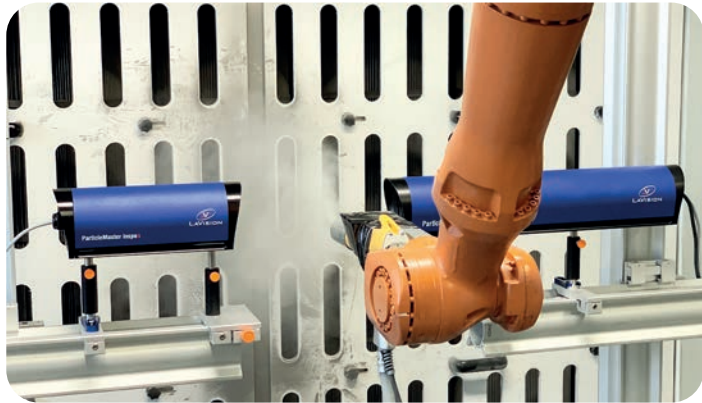

Homecare & beauty and medical sprays

The quality of many small spraying devices, such as home care and beauty or medical sprays is influenced by a combination of packaging, dispensing method and product composition. Optical spray characterization offers many advantages to achieve the best spray properties:

- ▶ Spray process optimization in R&D
- ▶ Quality control QC of aerosol devices
- ▶ Speed-up product design
- ▶ Compliance with safety regulations
- ▶ Non-intrusive spray test

Comprehensive digital spray characterization

ParticleMaster inspex sizing can be combined with LaVision's **SprayMaster inspex** systems to get a comprehensive characterization of all types of sprays. In addition to droplet and particle sizing, **SprayMaster inspex** systems measure spray pattern and spray plume geometry. The multifunctional systems are designed for detailed spray characterization for quality control and production monitoring as well as for R&D in paint and coating atomization processes.

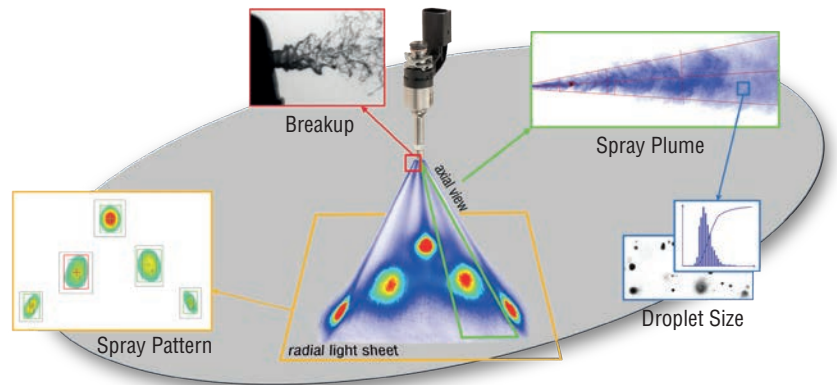

Comprehensive digital spray characterization for automotive fuel injection system



Production monitoring and quality control

Food stuffs, chemicals, pharmaceuticals, cosmetics and building materials are often provided in the form of powders and granulates. The production of these is a central part of many processes. Online monitoring of the product and process is essential to reduce production costs and ensure quality.

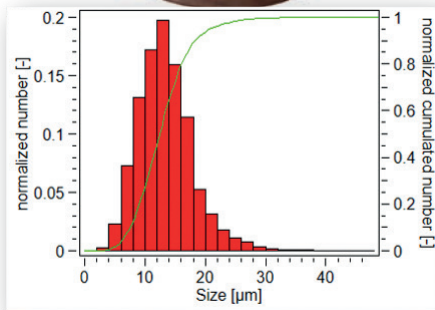
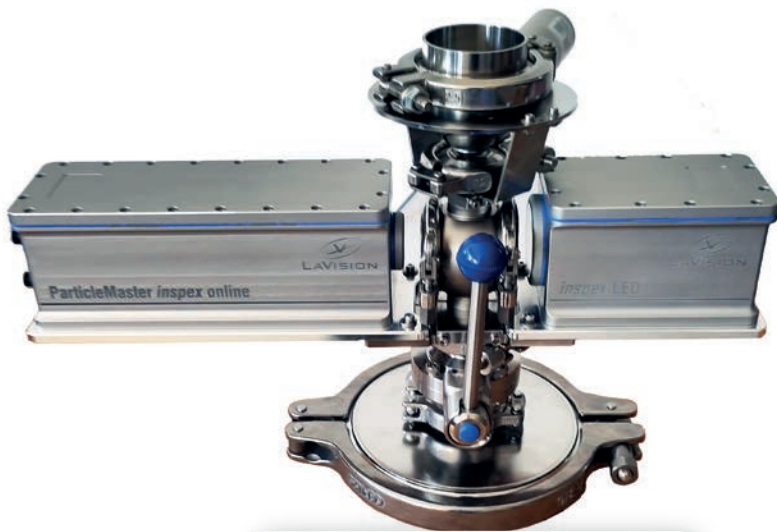

Powder production monitoring

Online particle monitoring in production processes reduces costs, downtime and wastage while increasing product quality through:

- ▶ Instantaneous indication of process status
- ▶ Continuous monitoring of product quality
- ▶ Online control loop to optimize production parameters
- ▶ Immediate warning when production errors occur

Monitoring powder production for example by spray drying can help to make production processes more efficient. Particularly for applications such as ceramic powder production where the size distribution is critical. Product specific probe preparation is often the key component to each application.



Digital sieving

Quality and content of agricultural goods varies widely by nature. Crop, weather, supplier, harvest timing and many more factors have an influence. Shadow sizing can be used to quickly and efficiently digitally filter crop samples in terms of size and shape to determine the composition of the agricultural goods from the crop delivery to any critical position in the processing chain up until the final product.

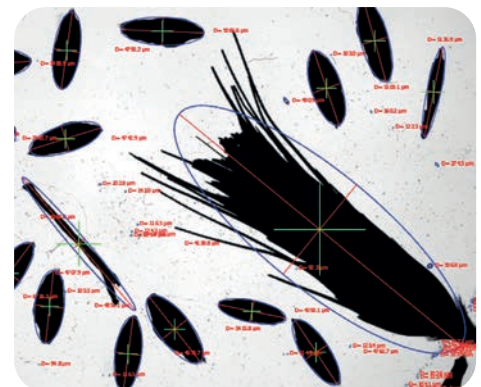



ParticleMaster *inspex* online provides a complete solution for production monitoring of particles. Hardware and software are optimized for operation in an industrial environment.

The ParticleMaster *inspex* online combines the advantages of Dynamic Image Analysis with an easy-to-use design.

- ▶ Online in-situ particle imaging
- ▶ No sample preparation required
- ▶ Simple integration at process sight glass
- ▶ Rugged sensor design IP67
- ▶ Fully factory pre-calibrated
- ▶ 24/7 automated operation
- ▶ Hygienic housing available for food production areas (designed to E 1672-2:2019)

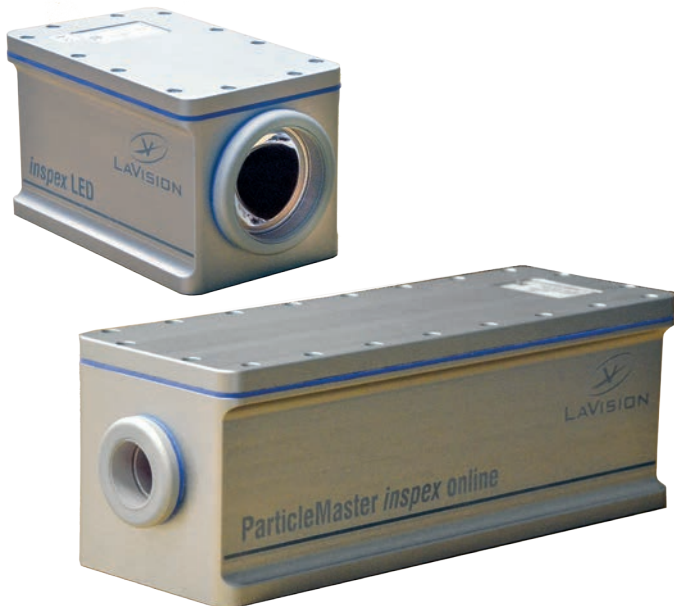
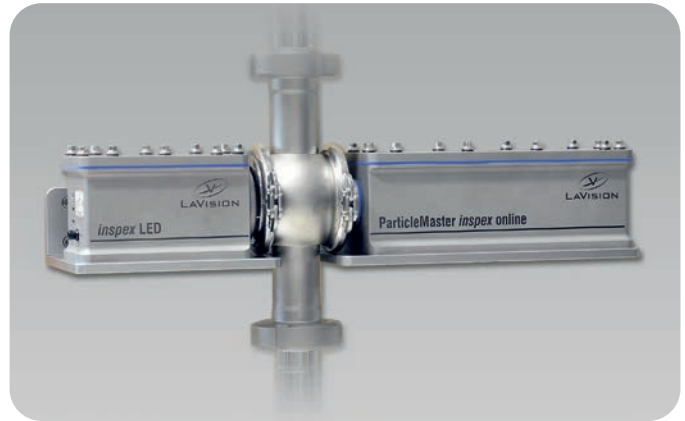

Rugged sensor

The ParticleMaster *inspex* online consists of the following components:

- ▶ Online probe incorporating the high magnification particle imaging system
- ▶ Online LED illumination unit

Both components come mounted on a base plate. Four probe models are available featuring different particle size ranges (starting at 10 μm or 4 μm) and measurement capabilities. The “S” models measure particle size only while the flow models “F” can measure particle velocity in addition to particle size.

Mounting is easily adapted to most applications.

Applications

- ▶ Spray nozzle production quality control
- ▶ Online monitoring of spray operations
- ▶ Powder spray recirculate and overspray surveillance
- ▶ Powder production size control
- ▶ Bulk powder and granulate sizing and quality control

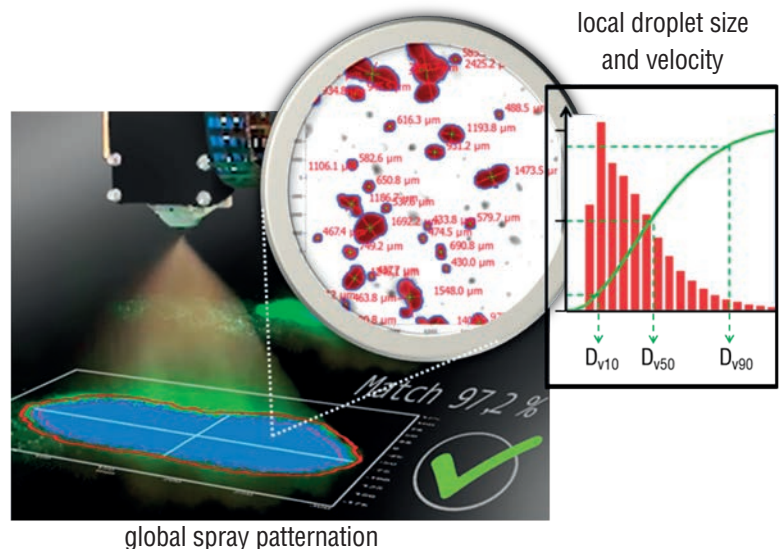



Modbus remote interface

ParticleMaster inspex software comes with a Modbus interface for seamless integration into production lines for 24/7 automatic quality control. This allows remote control of the measurement system and fully automatic sensor operation of the sizing measurements. The remote interface gives full control of the measurement operation and access to live particle statistics information.

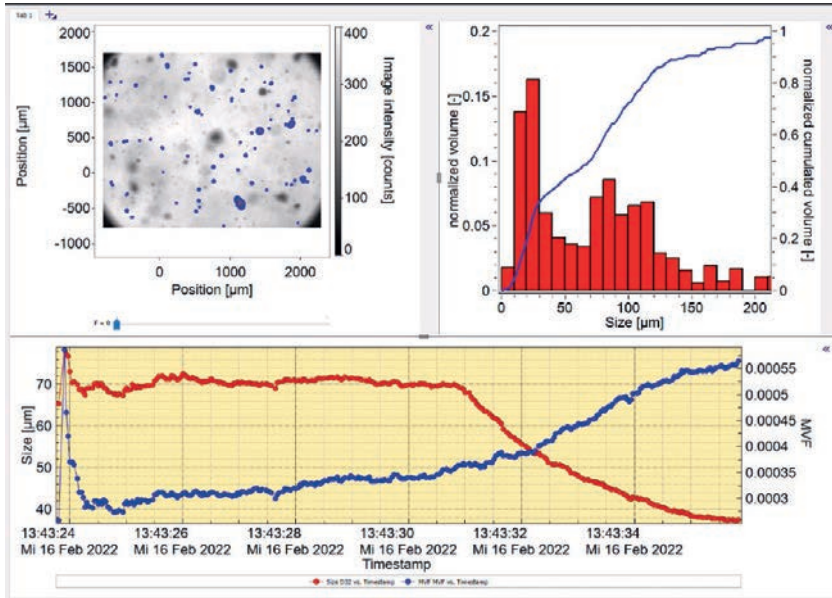

Online data processing

The **ParticleMaster inspex** software performs live dynamic image analysis. In addition to remote access of particle statistics via Modbus the software also gives real time visual feedback of the data to help machine operators make fast decisions and adjustments the process. Size distribution histograms, particle images and the trend graph give information about the instantaneous status and process history in easy to interpret information.

Customized solutions

Industrial machines are optimized for a specific application. The seamless integration of the a sensor or measurement system is necessary to avoid reducing the efficiency of the operation.

LaVision offers customization modules for **ParticleMaster inspex** systems tailored to an individual application to minimize operational risk and maximize performance. Let your process benefit from our many years of experience in creating custom interfaces for our **ParticleMaster** software.

Custom user interface software module

fully customized solution for particle sizing applications including

- ▶ Customized user interface
- ▶ Customized user management, processing, display and export functions

Custom remote interface software module

- ▶ Fully customized machine control interface including
- ▶ Customized communication protocol and data transfer (e.g. Modbus, JSON, I/O-lines, TCP/IP)
- ▶ Full remote control operation
- ▶ SDK including simulation client/server

The screenshot shows the software interface with the following sections:

- Test Plan Information:**

Parameter	Unit	Value
part number		ABC-123-456789D
sub part code		xyz-bf-13
material code		CW452K
reference spray pattern		ABC123-Ref04
- Parameter Input:**

Parameter	Unit	Value
pressure	bar	17.5
distance	mm	150
spray fluid		D1 water
quarantine		ZF
- Cumulated statistic results:**

Statistic	Measurement
images	100
particles	4305
Ns	32525.0
D10	13.4 µm
D32	16.6 µm
Dv10	11.8 µm
Dv25	14.1 µm
Dv50	17.2 µm
Dv75	21.7 µm
- Match:** 96.4% (with a green checkmark)
- Buttons:** Start spray test, Remote connect to server, Accept spray result OK, Decline reject spray.
- Visuals:** A size distribution histogram and a particle image with overlaid statistics.



LaVision's **ParticleMaster *inspex*** system is especially designed for quality control applications in industrial environments. It serves as a highly integrated laboratory and testing tool for the measurement of size, shape and velocity of spray droplets, particles and grains.

The **ParticleMaster *inspex*** combines the advantages of high-magnification shadow imaging with an easy-to-use design. When particle properties are important process parameters and have to be monitored in real time or in-line, our **ParticleMaster *inspex*** shadow systems are the right choice.

The compact and highly integrated design of the **ParticleMaster *inspex*** aims for daily laboratory use and quality control testing. The system is ready to use out-of-the-box, splash-proof and eye-safe. A well-defined mechanical interface allows the integration into existing test benches.

ParticleMaster *inspex* measured quantities

- ▶ Size, shape, orientation, perimeter of individual particles and droplets
- ▶ Velocity and mass flux from dual frame images
- ▶ Cumulated statistics D_{10} , D_{32} , percentiles D_{v10} , D_{v50} , D_{v90}
- ▶ Size histograms, scatterplots

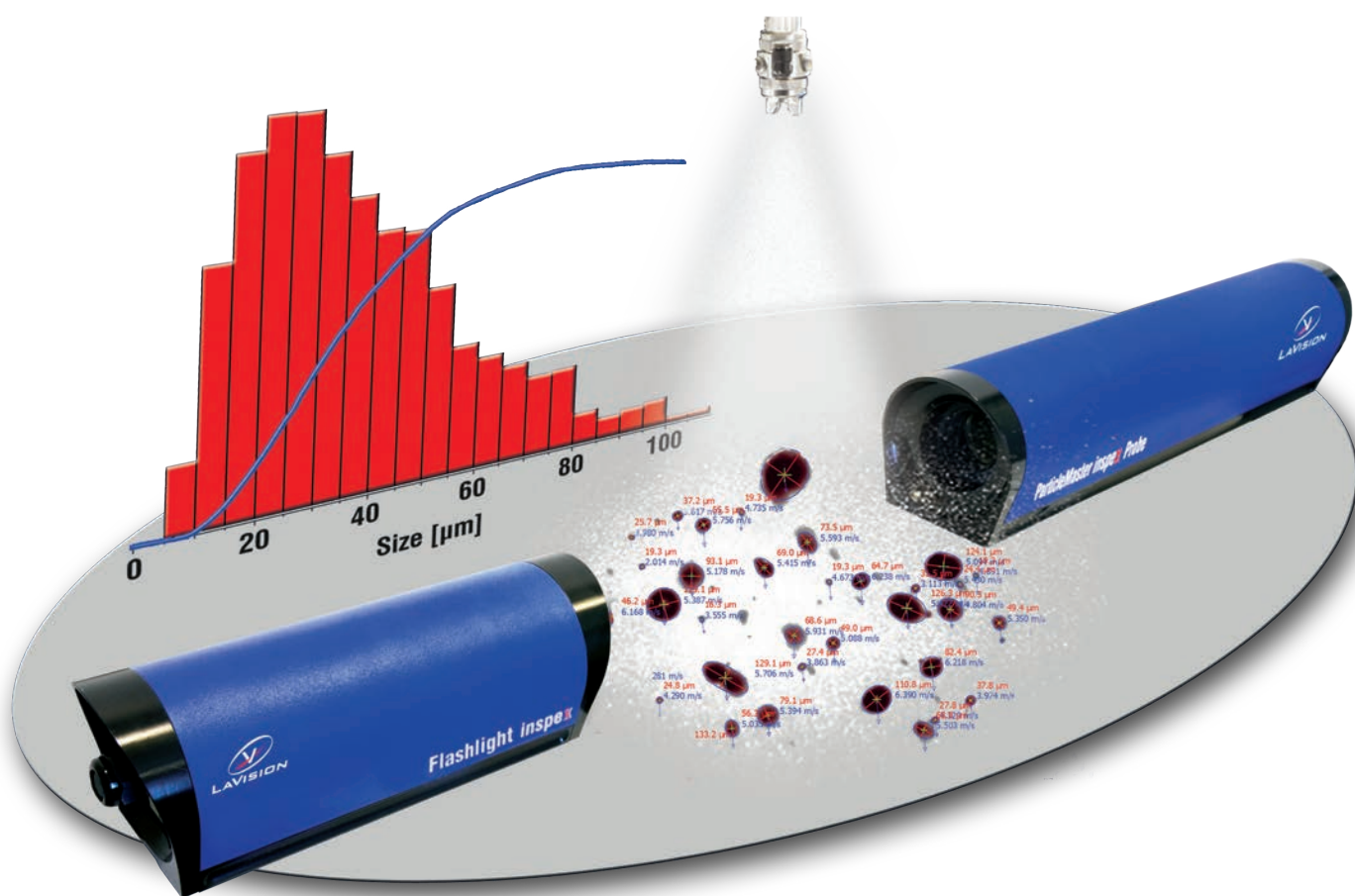

ParticleMaster *inspex* system features

- ▶ In-situ particle imaging: size, shape and velocity
- ▶ No sample preparation required
- ▶ Compact self-contained probes and lights
- ▶ Fully factory aligned – no customer calibration needed
- ▶ Includes size and depth-of-field calibration
- ▶ Eye-safe LED operation
- ▶ Splash proof IP54 design

Factory calibration

The **ParticleMaster *inspex*** is delivered with a factory calibration including

- ▶ Size and velocity calibration
- ▶ Depth-of-field calibration for absolute density and flux
- ▶ Center of measurement location

The **ParticleMaster** software recognizes each individual **ParticleMaster *inspex*** probe and loads the corresponding calibration data automatically. Due to the factory calibration a probe can be easily swapped and replaced by another one in shortest time and with high reproducibility.



ParticleMaster *inspex* components

ParticleMaster *inspex* probes are the heart of each system. They contain a high-resolution camera with a high-magnification lens in a solid splash-proof enclosure. The factory aligned and calibrated probes allow a quick and reproducible setup.

The probes are available with a camera for sizing only („S“ series) or for additional flow measurements with double-exposure included („F“ series). Different working distances are available: for small droplets a short working distance is favorable, while larger working distance can be more convenient for larger scale sprays or for measurement in spray chambers.



The **ParticleMaster *inspex*** flashlight is an eye-safe LED optimized for ultra-short illumination. Flashes as short as a 100 ns freeze any motion blur of most particles. Its splash proof rugged design makes it feasible for in-situ measurements and industrial applications.

The integrated double pulse feature of the LED supports the velocity measurement capabilities of the „F“ series probes. A high-current mode for maximum brightness turns on automatically for the short pulses. The flashlight is compatible with all **ParticleMaster *inspex*** probes but also with high-speed cameras for research systems.



The **ParticleMaster *inspex*** controller integrates powerful computing hardware with precise triggering and all required power supplies. The entire system is unboxed and operational within a few minutes time.

- ▶ Quad core CPU, fast SSD, large HDD
- ▶ **PTU X** timing unit for system control and versatile triggering
- ▶ Power supply and interface to probe and flashlight
- ▶ **DaVis** software for data acquisition, management and visualization
- ▶ **ParticleMaster** software package for particle image analysis

ParticleMaster *inspex* in automated quality control

LaVision's imaging software **DaVis** can be integrated into 24/7 fully automated production environments. A customizable remote control interface turns the system into a production line testing tool. Either manually operated or machine integrated operation the interface speeds up testing with predefined operation templates and integrated PDF report generation.





ParticleMaster Shadow software

All **ParticleMaster** systems are based on **DaVis** and the powerful **ParticleMaster** analysis software package.

The **ParticleMaster Shadow** software offers interactive particle detection and statistics generation. Images taken live from the camera or loaded from recordings on disk are processed automatically in the background, while the operator can fine-tune particle detection parameters or live filters. Any action will be immediately reflected in the displayed results. Giving instant feedback provides an intuitive approach to high-magnification shadow imaging with a quick learning phase.

The **ParticleMaster Shadow** software includes

- ▶ Direct feedback on operation interaction
- ▶ Live camera processing
- ▶ User customized layout
- ▶ Result export
- ▶ Automated mass processing using DaVis hyperloop function
- ▶ Detailed insight into each detected particle or droplet

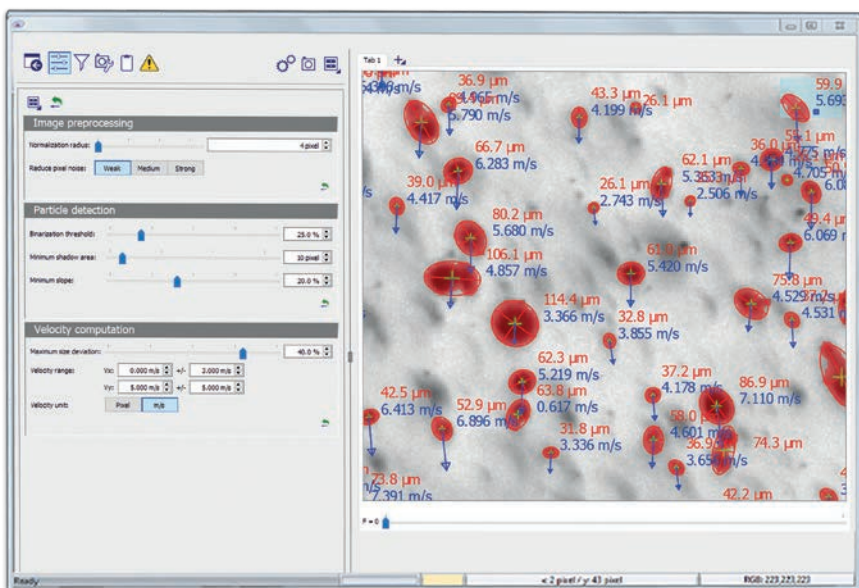

Interactive particle recognition

Particles, droplets and bubbles are detected by their shadow image. The detection can be optimized for contrast, brightness and size. Any operator interaction leads to an immediate recalculation and gives highly intuitive instant feedback.

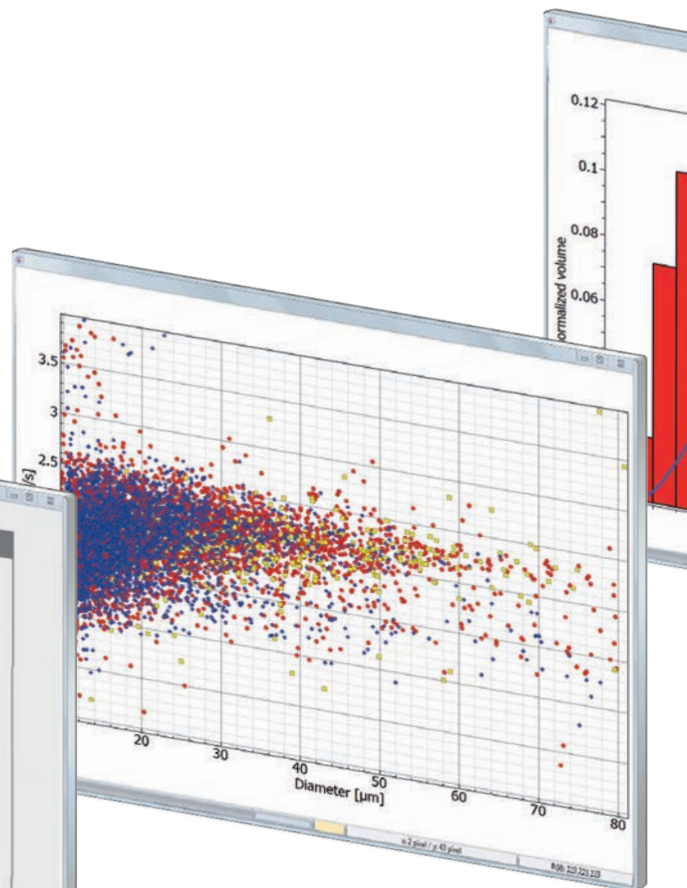
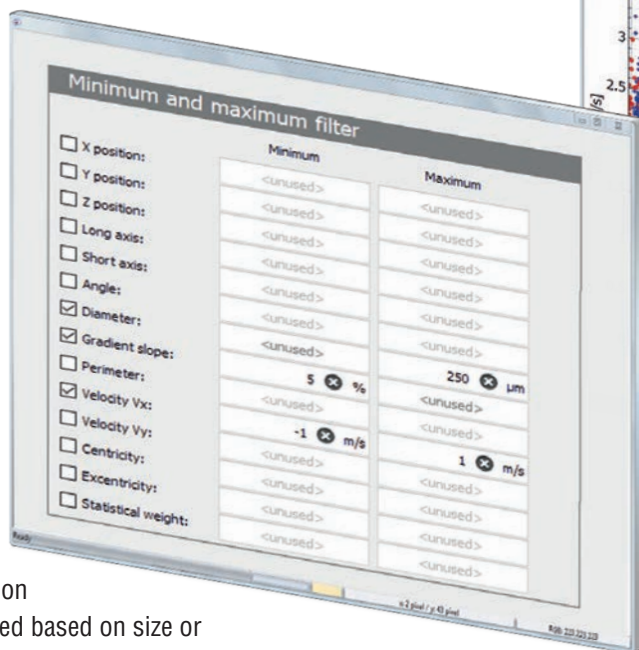

Particle filters

Once particles or droplets are detected, their contribution to any statistics can be filtered based on size or morphology with immediate effect on the result output. A time based filter allows investigating the temporal evolution of transient phenomena like pulsed sprays.

Scatterplots

Scatterplots show general trends in the particle distribution. With an extra filter for classification analysis of complex data is even simpler.

Individual layout

Every measurement task is different. Therefore, the **ParticleMaster Shadow** software offers a user definable layout. Windows can be arranged to show all relevant information on a single screen. All display features of particle images, histograms and scatterplots are easily adjusted. Once a setting is to your satisfaction, you can conserve it using a DaVis shelf. Multiple tabs allow changing quickly between different layouts and offer a high degree of individualization.

Shadow image preview

High-magnification imaging has the striking benefit that you can directly see the particles. Information like detected shadow area, center of gravity, longest and shortest axis, size and velocity are displayed on top of each particle image. You can replay the images using the integrated data movie player and see the effect of changing detection parameters.

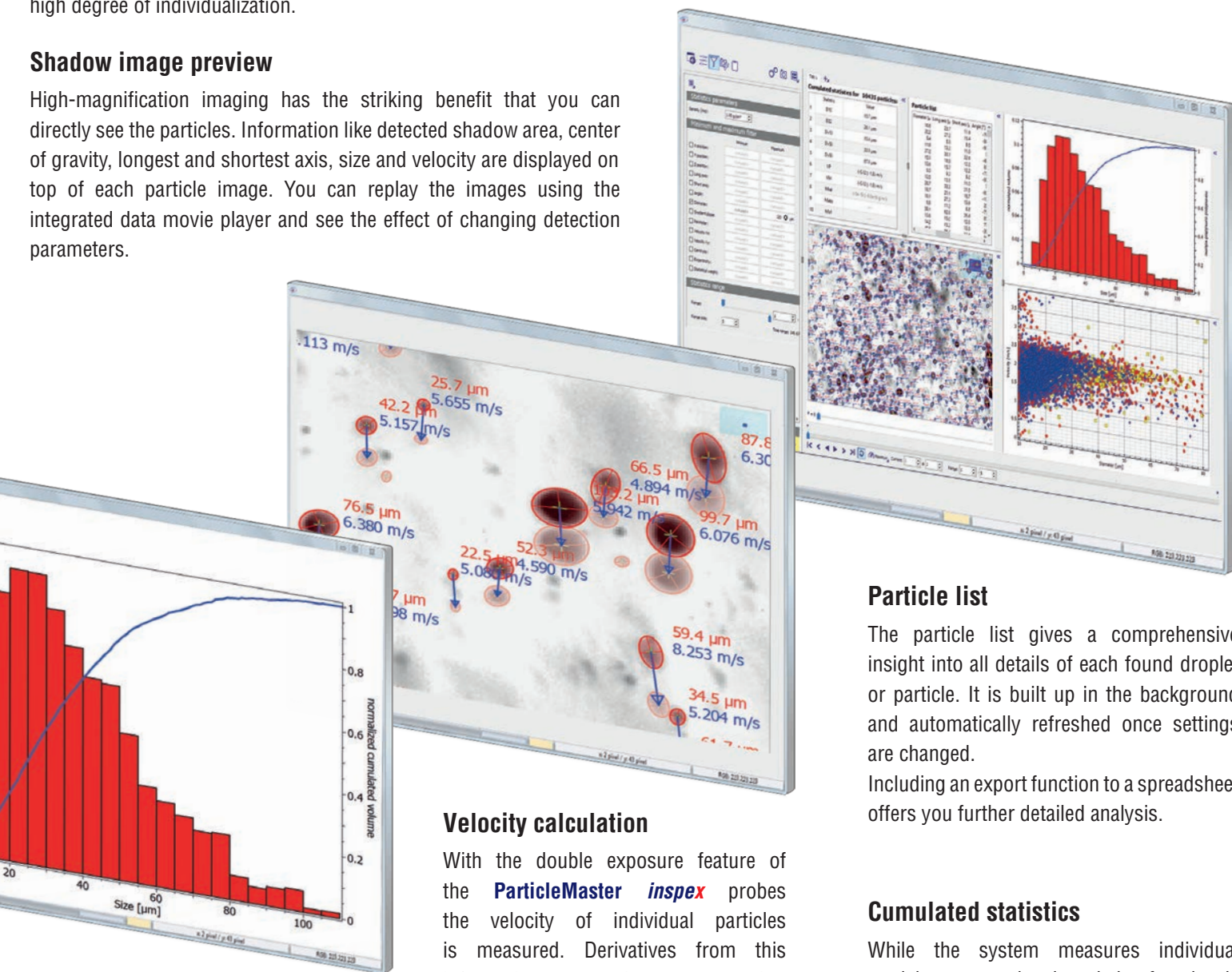

Particle list

The particle list gives a comprehensive insight into all details of each found droplet or particle. It is built up in the background and automatically refreshed once settings are changed.

Including an export function to a spreadsheet offers you further detailed analysis.

Cumulated statistics

While the system measures individual particles, a cumulated statistics function is built up for data aggregation. This includes the commonly reported mean diameters, but also average velocity and mass flux information for double pulse and **DOF** calibrated systems.

Velocity calculation

With the double exposure feature of the **ParticleMaster inspex** probes the velocity of individual particles is measured. Derivatives from this information are volume or number weighted average velocity and mass flux.

Export

Export of screenshots and data tables including the entire particle list is part of the processing chain. This allows to automate the export of larger data sets using the DaVis hyperloop feature.

Histograms

Size histograms belong to the most important results. Histograms can be linear, logarithmic or according to ISO 565 sieves. Probability is shown based on number or volume. Once the **DOF** calibration is applied, the histogram reports absolute number and mass densities. Multiple size histograms can be shown at the same time, each with individual settings.



High accuracy particle characterization

LaVision's advanced Depth-of-field (DOF) calibration method not only ensures highly accurate particle sizing measurements. It also ensures that the **ParticleMaster** system can deliver true particle statistics, absolute number density, volume fraction and absolute mass flux of the particle flow.

All **ParticleMaster inspex** systems are fully pre-calibrated and benefit from the DOF calibration and high accuracy particle sizing out of the box.

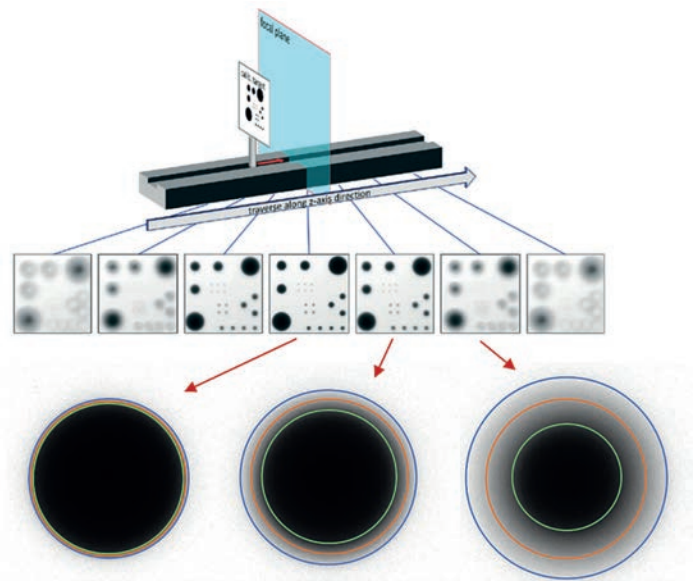

Example of sharp particle in the focal plane with clearly defined diameter and diffuse particle out of the focal plane with blurred edge and ambiguous diameter

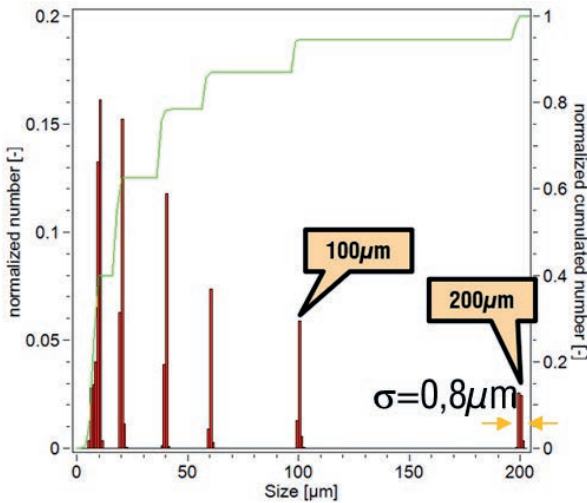

Highly accurate particle sizing

Particles passing through the measurement volume between a light source and the imaging camera produce shadows on the camera's sensor and reduce the light intensity on the camera sensor. Particles in the focal plane have high contrast and sharpness. In this case the diameter detection has a high accuracy. Particles distributed in the depth of field (DOF) become increasingly blurred and have a lower contrast and sharpness, depending on their out-of-focal-plane position and size. Without proper compensation the diameter determination is thus highly dependent on the particle detection settings, resulting in deviating particle diameters.

True particle statistics

The correlation between Depth-of-Field and particle size leads to a bias of the detection probability towards larger particles. When calculating statistics data from an ensemble of detected particles this behavior must be taken into account. The bias arising from it needs to be corrected in any case for a 3D volume.

In order to calculate absolute particle density related quantities, it is additionally necessary to know the physical size of the sample volume. The calibration of this value is implemented in the ParticleMaster software as the DOF calibration. This allows the correction of the statistical data to give true particle statistics.

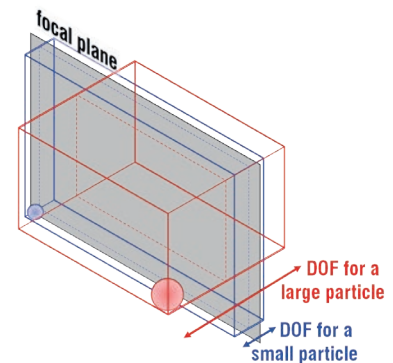

The depth (z-axis dimension) of the sample volume is influenced by the particle diameter

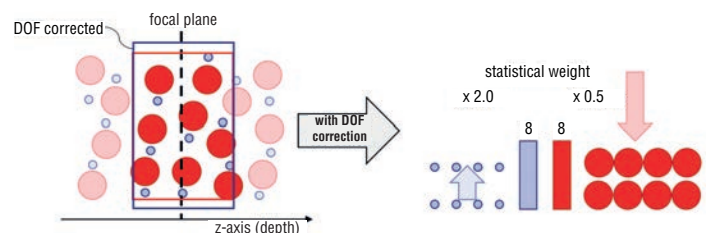
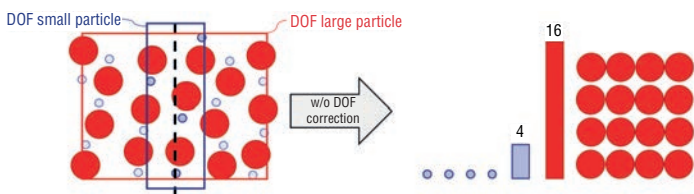



Density and mass flux

The DOF calibration outputs the precise measurement volume size for each particle size class. This allows the measurement of derived values such as absolute number density, volume fraction and absolute mass flux of the particle flow. Without knowledge of the measurement volume size this parameters can not be determined.

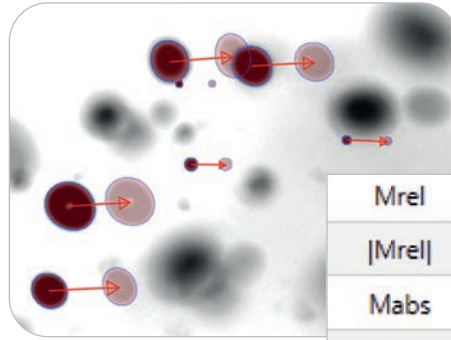

Mrel	(-1.1e-05 1.9e-06) g m/s
Mrel	1.1e-05 g m/s
Mabs	(-0.29 0.053) g/(cm ² s)
MVF	1.5465e-04 g/cm ³

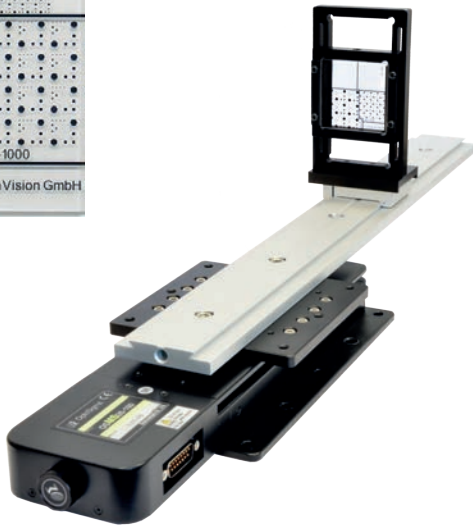
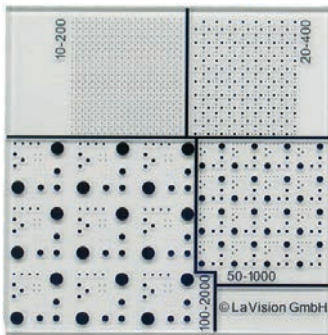

ParticleMaster calibration set

Unlike **ParticleMaster inspex** systems which are fully pre-calibrated, the **ParticleMaster Shadow** R&D systems with flexible optical setup need to be calibrated in-situ. A special transparent calibration plate was designed for the **ParticleMaster** depth of field calibration.

A **ParticleMaster** calibration set is available, including a motorized stage, to perform fully automated DOF calibrations.

DOF Calibration

ParticleMaster inspex software allows automated DOF calibration measurements with the calibration kit. A separate dialog then performs the DOF calibration for all detection settings, which can then be used for the calibrated measurement setup.

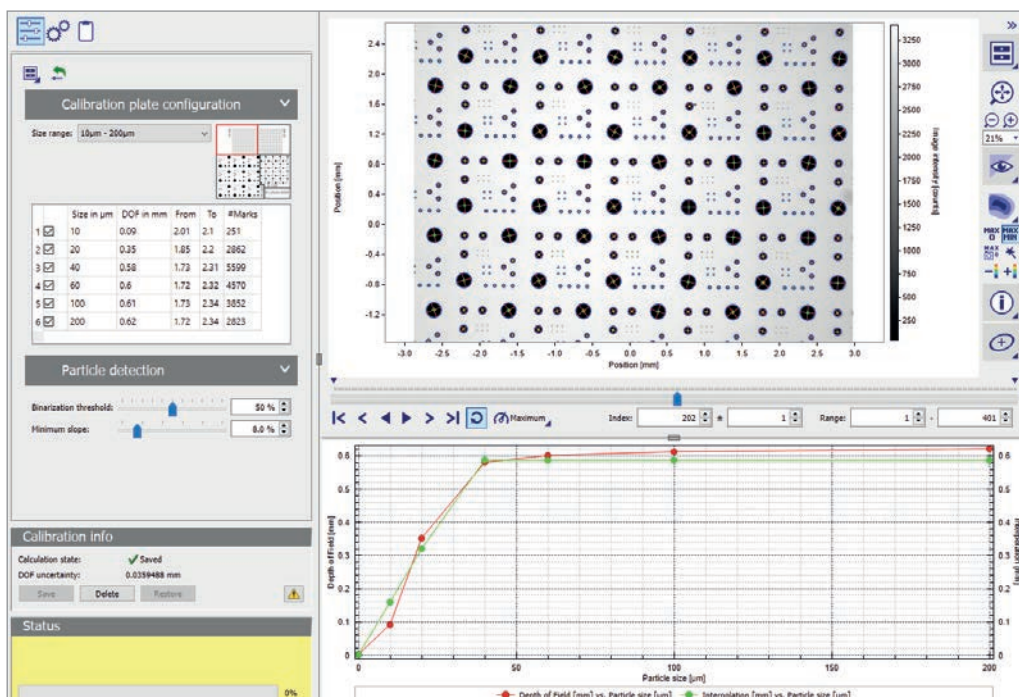

Depth-of-field (DOF) calibration software



ParticleMaster Shadow system components

ParticleMaster Shadow systems can be built of almost any LaVision camera and laser. This modular approach of all LaVision laser imaging systems opens a convenient and cost effective upgrade path from existing systems. All solutions benefit from high flexibility, especially required in research environment.

A **ParticleMaster Shadow** system can be designed based on a common principle from a large variety of cameras, lenses and illuminations.



The **High-Efficiency Diffuser Optics** yields more than a factor of 10 more light compared to the standard model. As a result, much less laser power is needed for e.g. particle sizing with LaVision's **ParticleMaster** systems. A laser with 15 mJ output power or even less is sufficient to analyze typical fields of view of a few mm.

The integrated collimating lens is ideally designed for high-magnification particle sizing applications. A laser interlock is included for safe use of the device together with a laser source. A fiber optics cable for remote positioning of the collimator head is available as an option.

High-magnification lens optics pick up the shadow image out of the measurement volume from a remote distance. Long-distance microscope lenses allow to measure tiny droplets and particles up to a meter stand-off distance, while close-up lenses and telecentric lenses grant high image magnification for the smallest particles down to the resolution limit of optics.

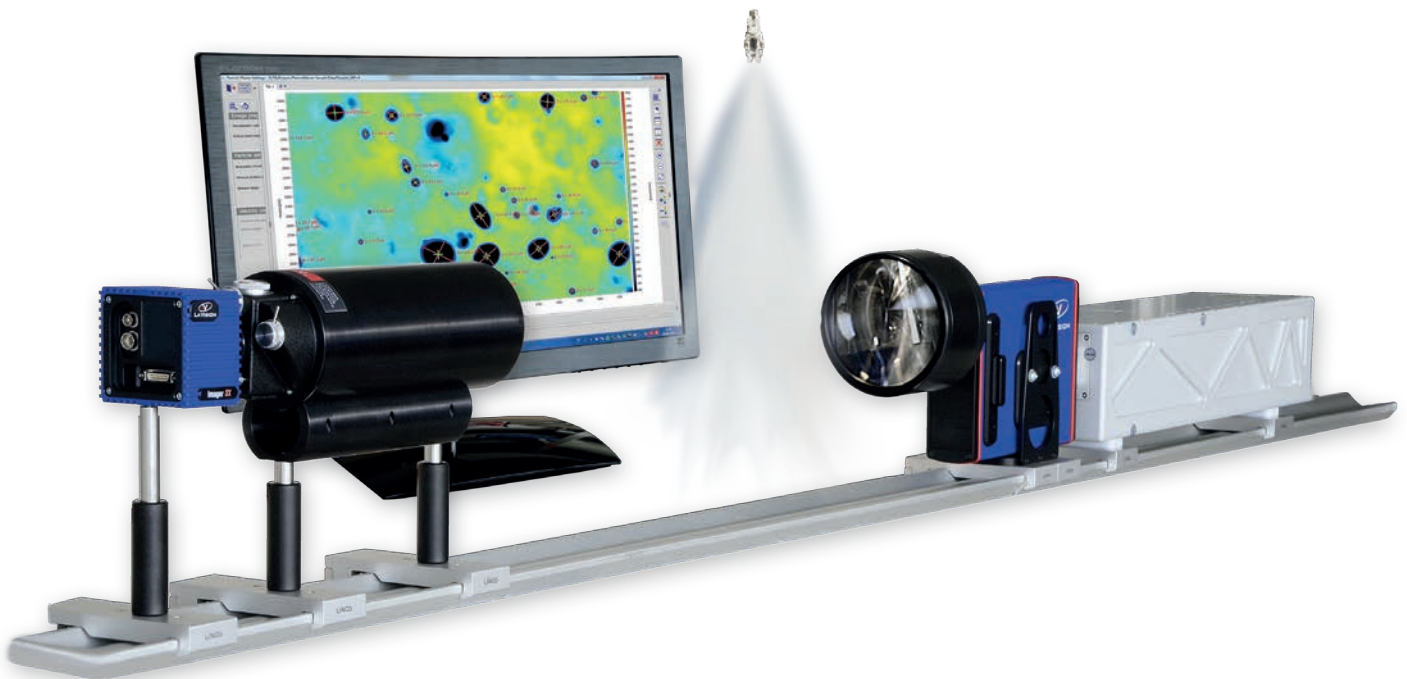



Laser imaging in sprays - Global Droplet Sizing

Laser light sheet imaging applied to sprays reveals instantaneous 2-dimensional maps of the relative Sauter Mean Diameter (SMD or D_{32}). Each snapshot represents the 2D distribution of the average droplet size, showing the dynamic behavior and the spatial structure of spray evolution.

A **ParticleMaster** system can be used as a calibration device to convert the relative size information from the LIF/Mie technique into absolute numbers.

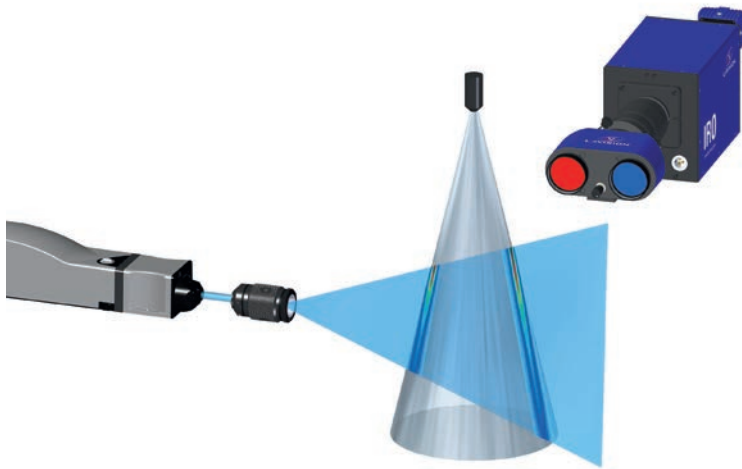

LIF/Mie imaging setup for global droplet sizing

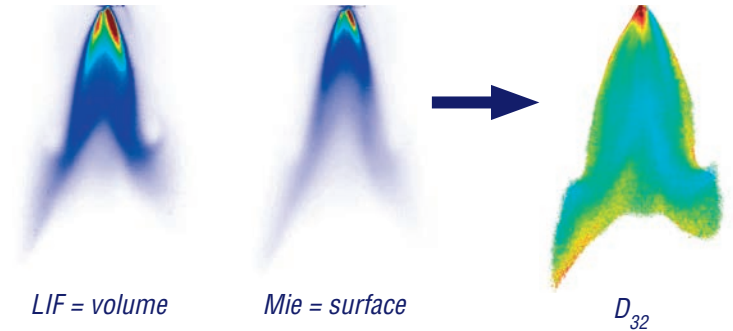

Tomographic shadowgraphy in multi-phase flows

Tomographic shadow imaging is used to reconstruct the bubbles in 3D space as well as the locations of the much smaller seeding particles dispersed in the liquid phase. Phase separation is performed using a software filter sensitive to the size difference between the seeding particles and the bubbles.

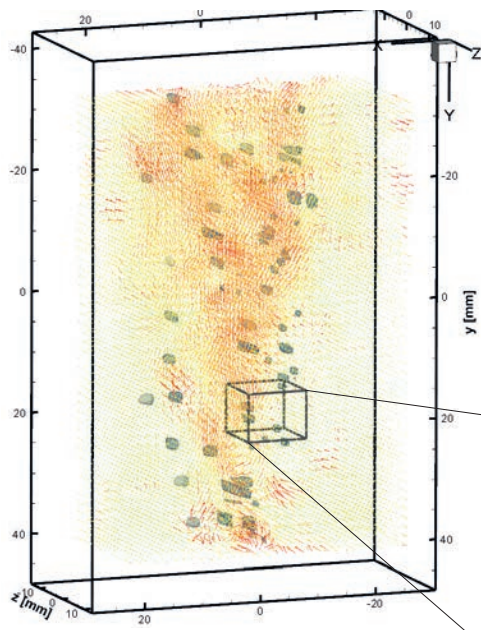

Snapshot of a time-resolved 3D presentation of a bubbly flow with a zoomed detail

ParticleMaster Tomo-Shadow system features

- ▶ 3D imaging based on tomographic shadowgraphy
- ▶ Phase separation based on shadow image size only
- ▶ State-of-the-art "Shake-the-Box" 4D-PTV algorithm
- ▶ Bubble shape, size and velocity
- ▶ 3D velocity and acceleration field of the liquid phase
- ▶ Only one backlight for volumetric illumination
- ▶ TecPlot™ presentation of both phases in one coordinate system

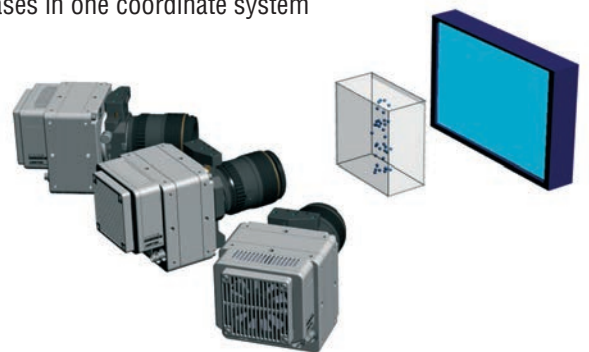

High-speed tomographic shadow imaging in multiphase flows

3D snapshot imaging of the two-phase flow shows nicely the interaction between rising bubbles and the induced flow field in the water tank. The tomographic shadow imaging technique is scalable in space and time: larger and smaller volumes can be investigated depending on the desired spatial resolution. With a selection of high-speed cameras the recording rate can be increased to study faster flow phenomena at a higher time resolution.

ParticleMaster

Intelligent Imaging for Particle and Droplet Characterization



Droplets

- ▶ Sprays
- ▶ Melts
- ▶ Spray drying

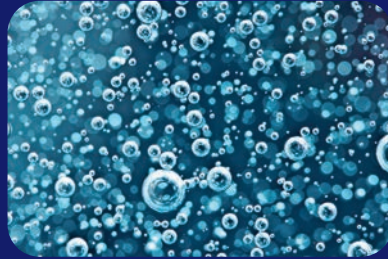

Bubbles

- ▶ Heat exchangers
- ▶ Multi-phase flows
- ▶ Cavitation



Particles

- ▶ Grinding
- ▶ Powders
- ▶ Grains

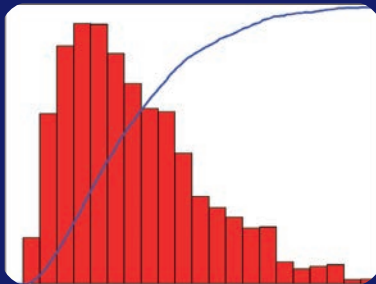

Size

- ▶ Diameter, D_{32} , D_{v50} , etc
- ▶ Size histogram

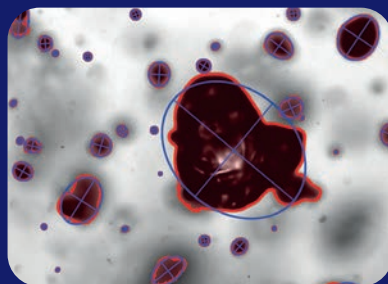

Shape

- ▶ Axis orientation
- ▶ Perimeter

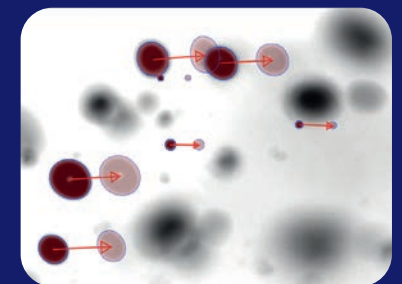

Velocity

- ▶ Spray dynamics
- ▶ Mass flux

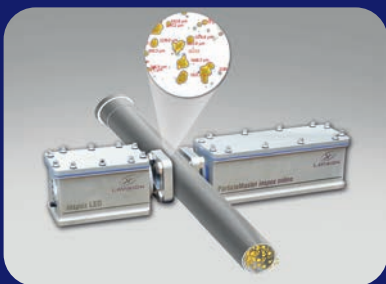

Quality Control

- ▶ Automatic & quick testing
- ▶ Process control interface



Industry

- ▶ Production monitoring
- ▶ Safe operation



Research

- ▶ Flexible system design
- ▶ Upgradable hardware

LaVisionUK Ltd

2 Minton Place / Victoria Road
Bicester / Oxon / OX26 6QB / United Kingdom
E-Mail: sales@lavisisionuk.com
www.lavisisionuk.com
Phone: +44-(0)-870-997-6532
Fax: +44-(0)-870-762-6252

LaVision GmbH

Anna-Vandenhoeck-Ring 19
D-37081 Göttingen / Germany
E-Mail: info@lavisision.com
www.lavisision.com
Tel.: +49-(0)5 51-9004-0
Fax: +49-(0)551-9004-100

LaVision Inc.

211 W. Michigan Ave. / Suite 100
Ypsilanti, MI 48197 / USA
E-Mail: sales@lavisisioninc.com
www.lavisision.com
Phone: (734) 485 - 0913
Fax: (240) 465 - 4306